

5/25/10

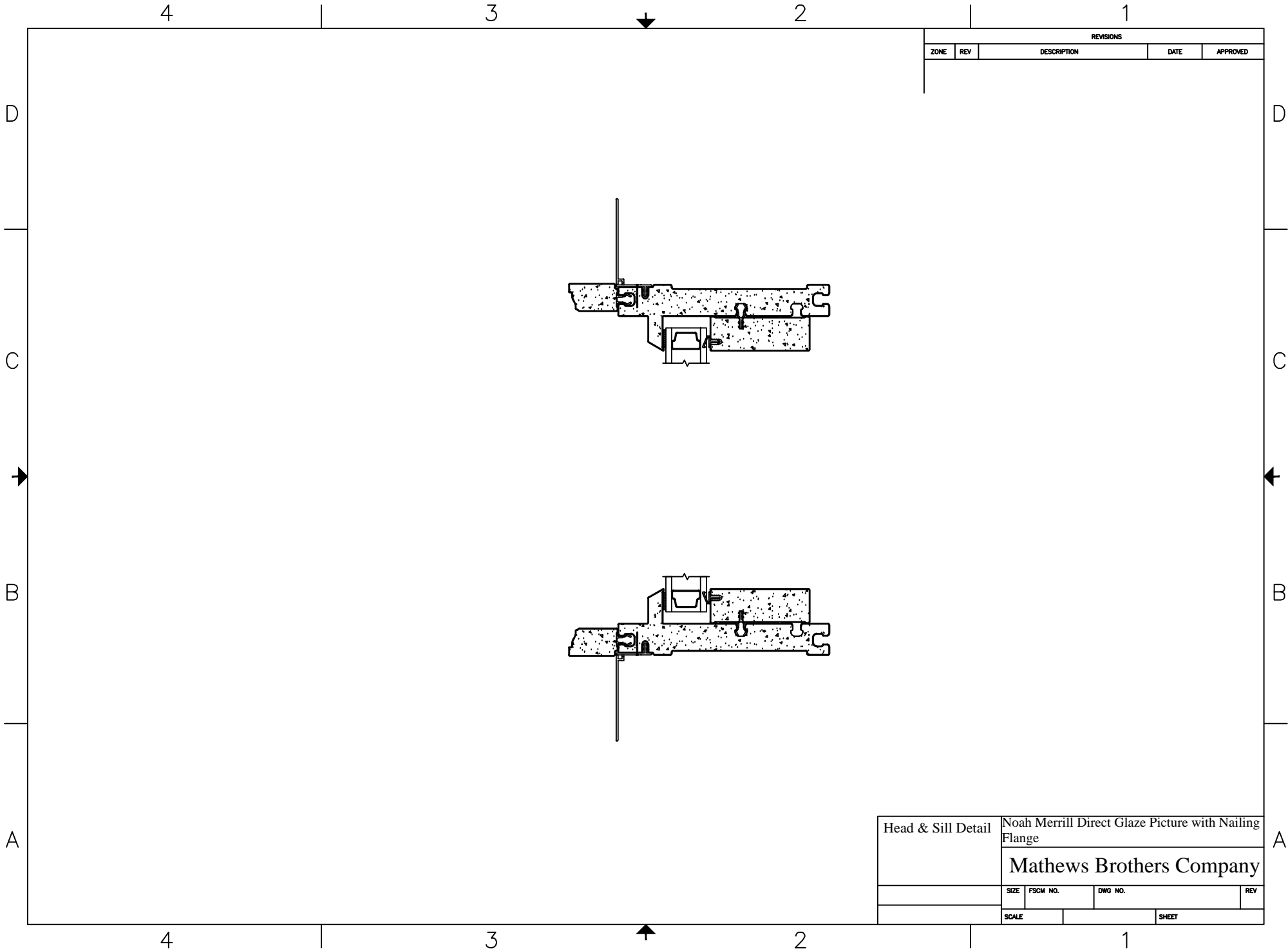

REVISIONS				
ZONE	REV	DESCRIPTION	DATE	APPROVED

Head & Sill Detail	Noah Merrill Direct Glaze Picture with Nailing Flange			
	Mathews Brothers Company			
	SIZE	FSCM NO.	DWG NO.	REV
	SCALE		SHEET	

5/25/10

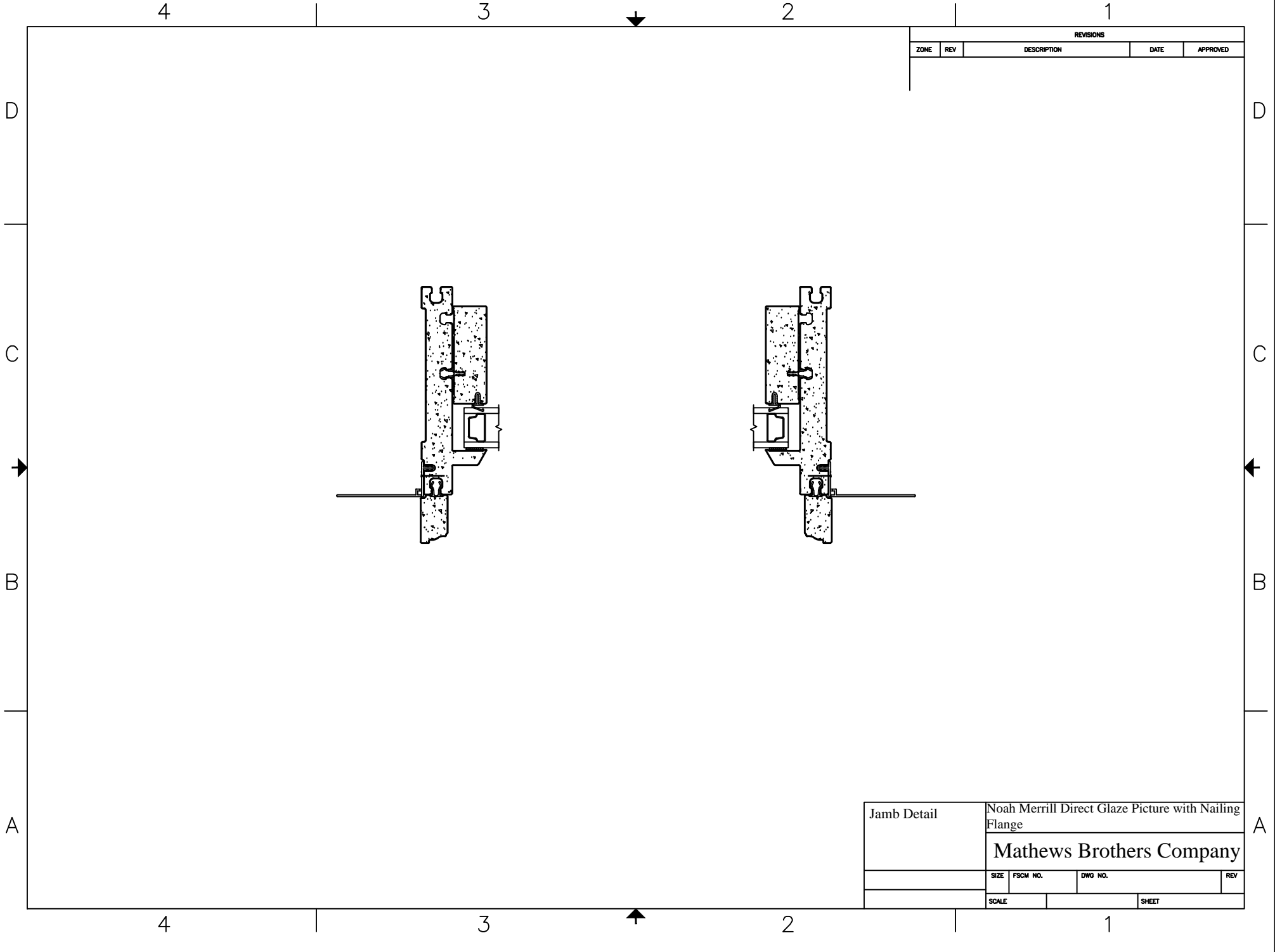

REVISIONS				
ZONE	REV	DESCRIPTION	DATE	APPROVED

Jamb Detail	Noah Merrill Direct Glaze Picture with Nailing Flange			
	Mathews Brothers Company			
	SIZE	FSCM NO.	DWG NO.	REV
	SCALE		SHEET	

5/25/10

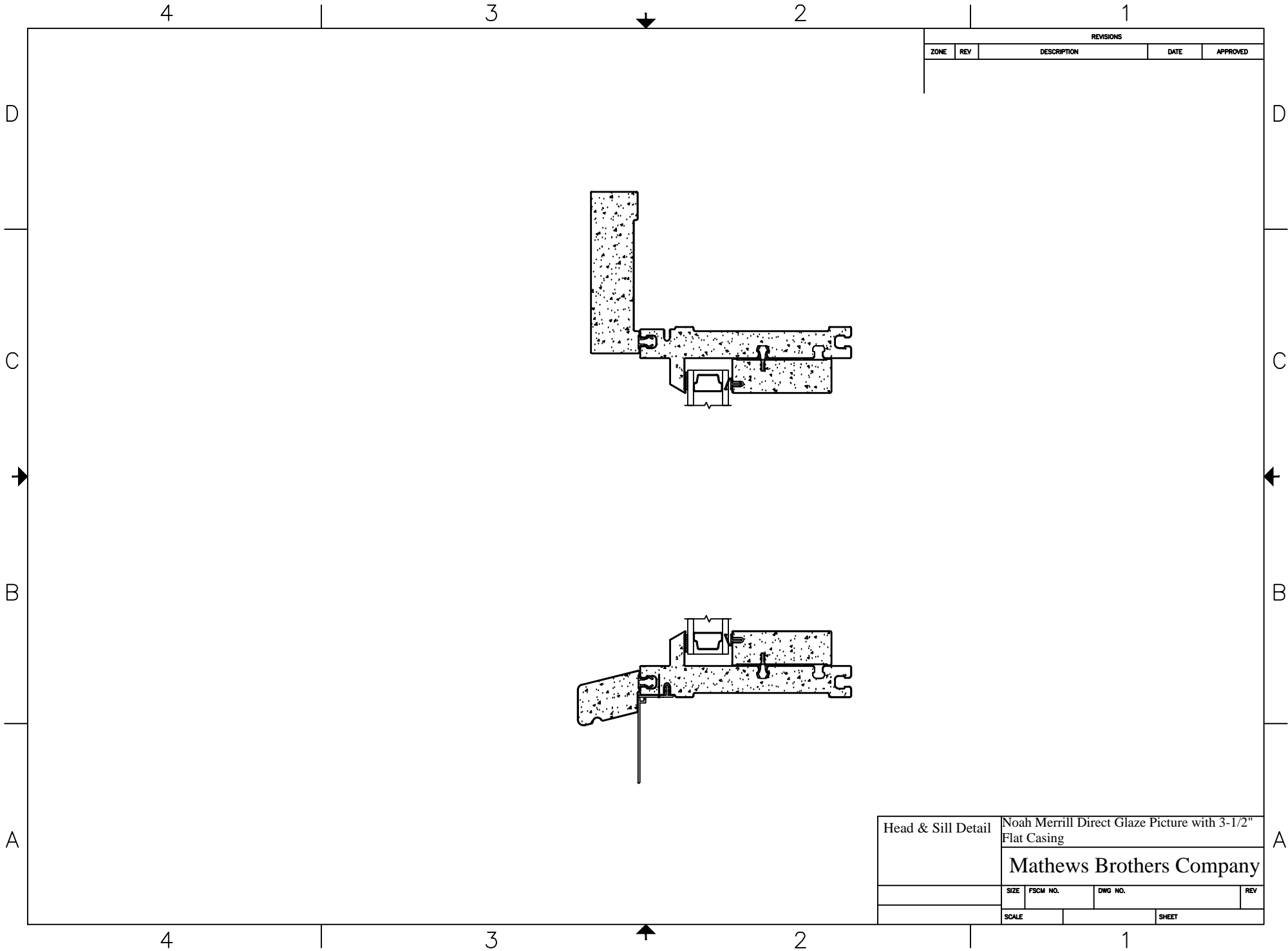

REVISIONS				
ZONE	REV	DESCRIPTION	DATE	APPROVED

Head & Sill Detail	Noah Merrill Direct Glaze Picture with 3-1/2" Flat Casing			
	Mathews Brothers Company			
	SIZE	FSCM NO.	DWG NO.	REV
	SCALE		SHEET	

5/25/10

D

C

B

A

4

3

2

1



REVISIONS				
ZONE	REV	DESCRIPTION	DATE	APPROVED

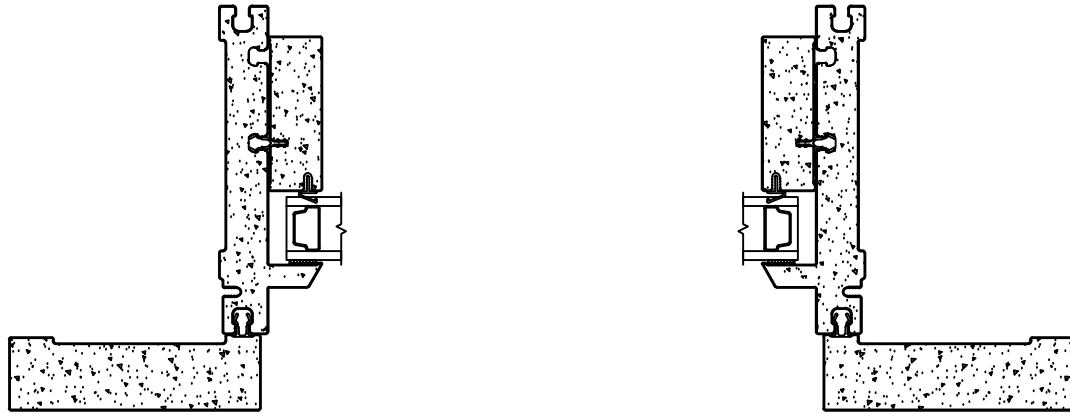

Jamb Detail	Noah Merrill Direct Glaze Picture with 3-1/2" Flat Casing			
	Mathews Brothers Company			
	SIZE	FSCM NO.	DWG NO.	REV
	SCALE		SHEET	

4

3

2

1

D

C

B

A

5/25/10

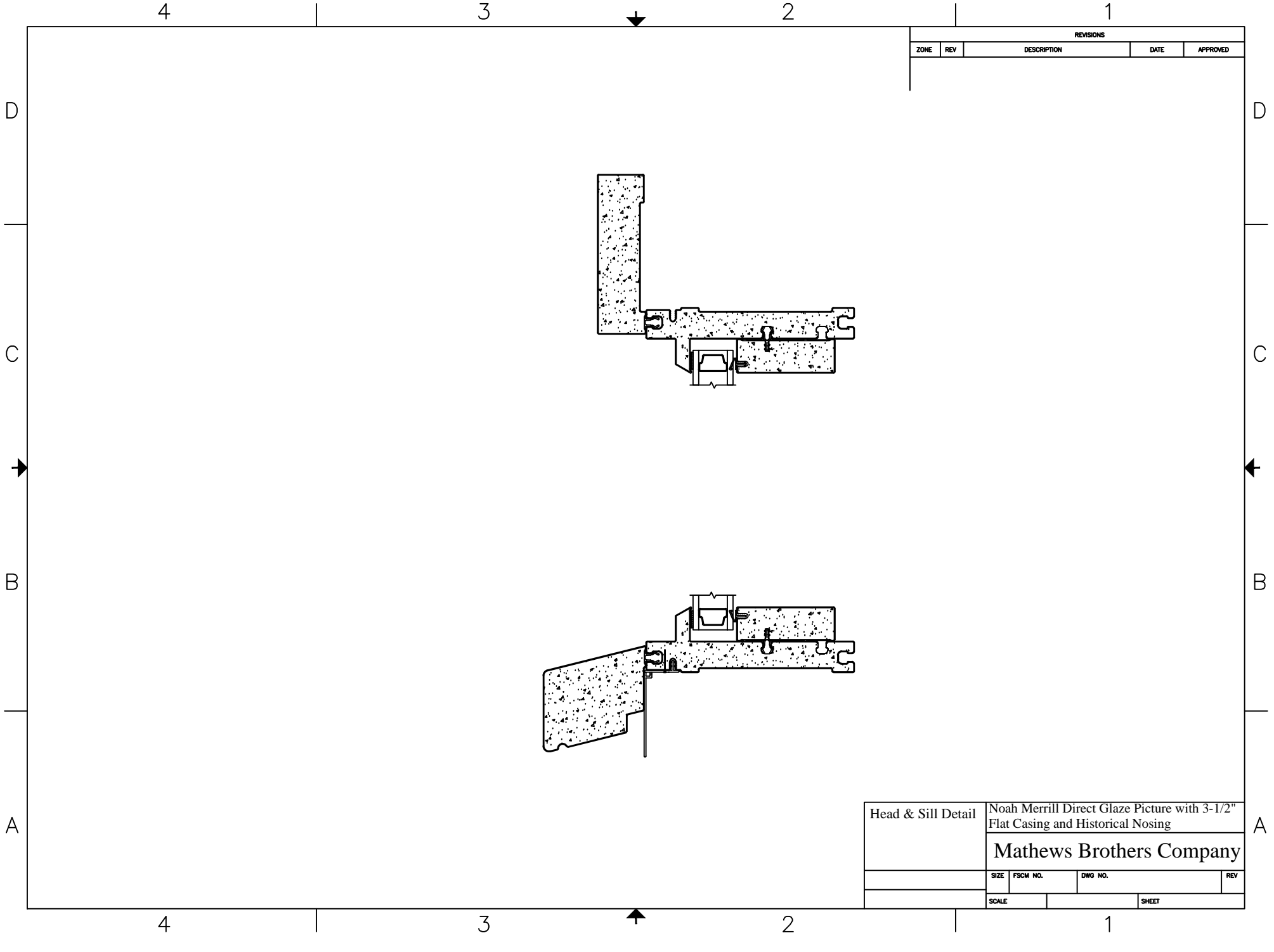

REVISIONS				
ZONE	REV	DESCRIPTION	DATE	APPROVED

Head & Sill Detail	Noah Merrill Direct Glaze Picture with 3-1/2" Flat Casing and Historical Nosing			
	Mathews Brothers Company			
	SIZE	FSCM NO.	DWG NO.	REV
	SCALE		SHEET	

5/25/10

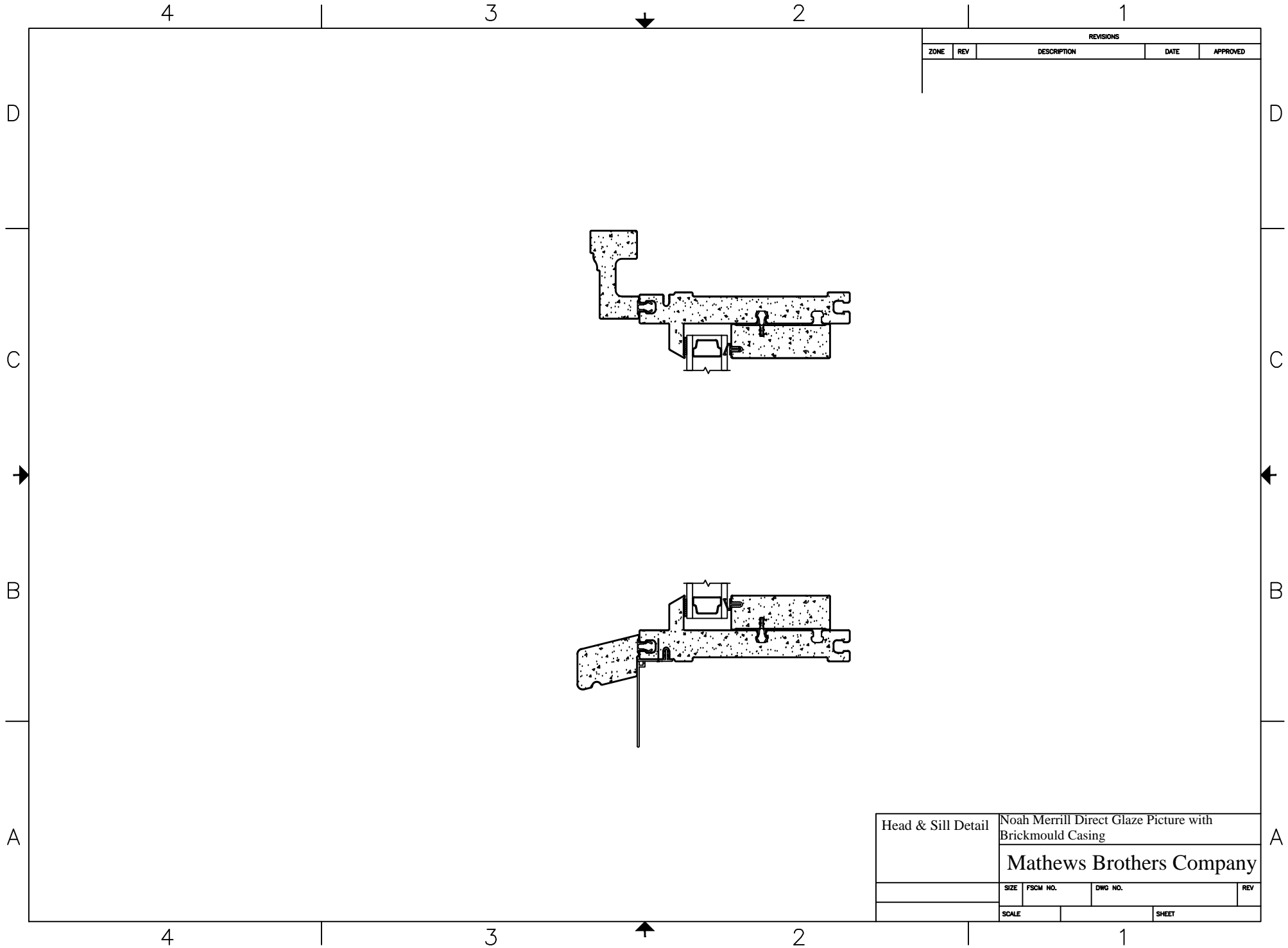

REVISIONS				
ZONE	REV	DESCRIPTION	DATE	APPROVED

Head & Sill Detail	Noah Merrill Direct Glaze Picture with Brickmould Casing			
	Mathews Brothers Company			
	SIZE	FSCM NO.	DWG NO.	REV
	SCALE		SHEET	

5/25/10

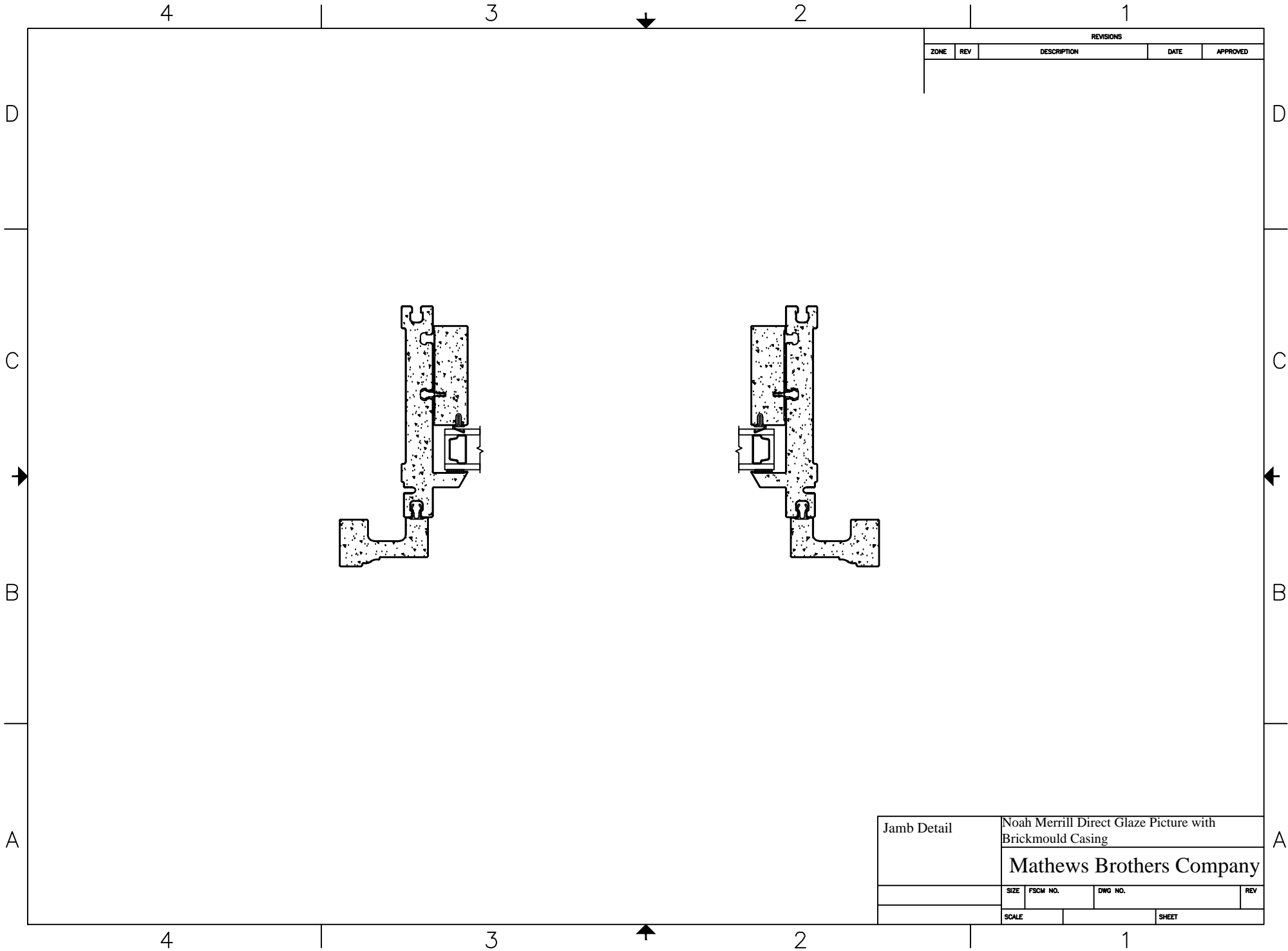

REVISIONS				
ZONE	REV	DESCRIPTION	DATE	APPROVED

Jamb Detail	Noah Merrill Direct Glaze Picture with Brickmould Casing			
	Mathews Brothers Company			
	SIZE	FSCM NO.	DWG NO.	REV
	SCALE		SHEET	

5/25/10

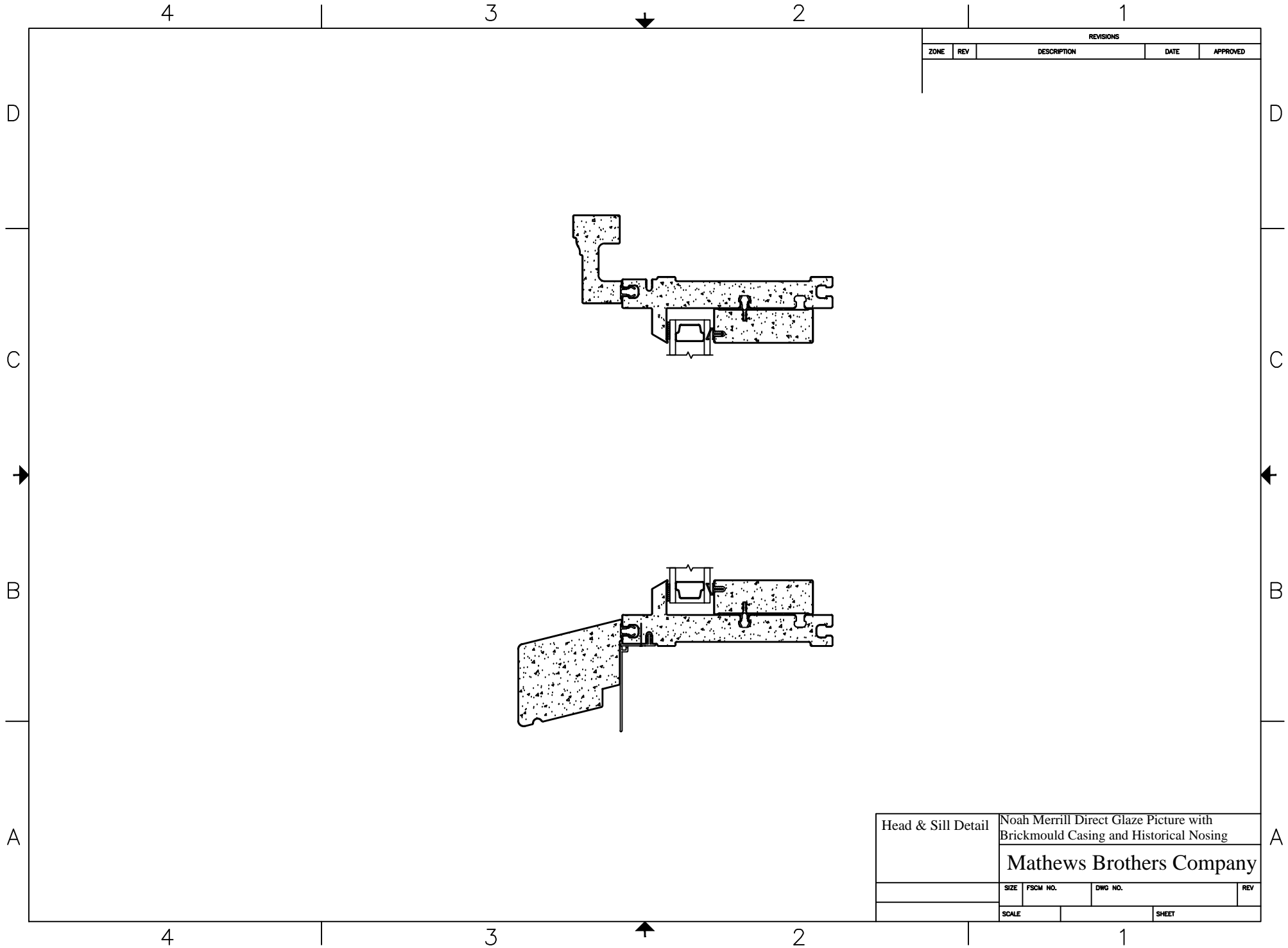

REVISIONS				
ZONE	REV	DESCRIPTION	DATE	APPROVED

Head & Sill Detail	Noah Merrill Direct Glaze Picture with Brickmould Casing and Historical Nosing			
	Mathews Brothers Company			
	SIZE	FSCM NO.	DWG NO.	REV
	SCALE		SHEET	

5/25/10

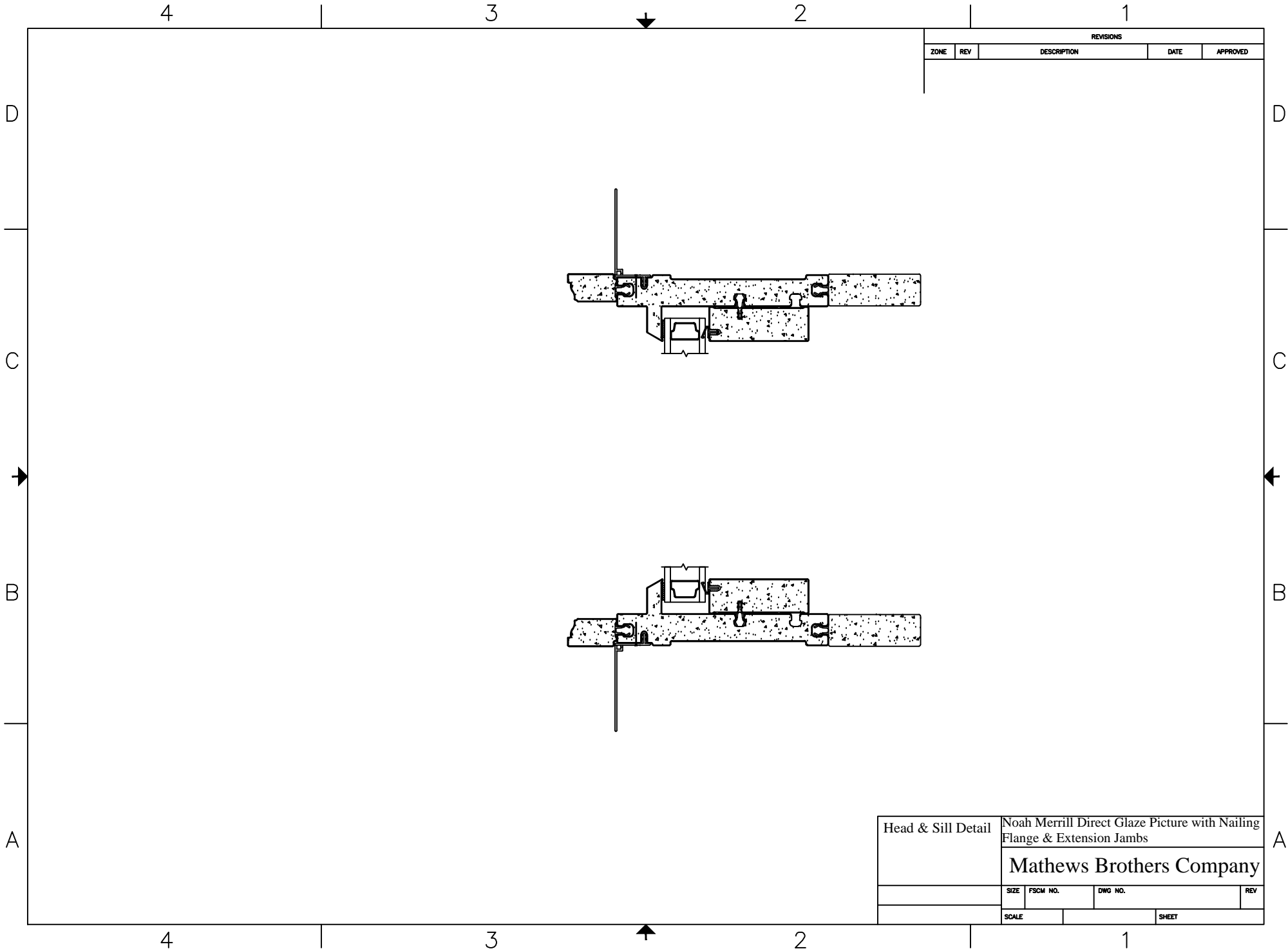

REVISIONS				
ZONE	REV	DESCRIPTION	DATE	APPROVED

Head & Sill Detail	Noah Merrill Direct Glaze Picture with Nailing Flange & Extension Jamb			
	Mathews Brothers Company			
	SIZE	FSCM NO.	DWG NO.	REV
	SCALE			SHEET

5/25/10

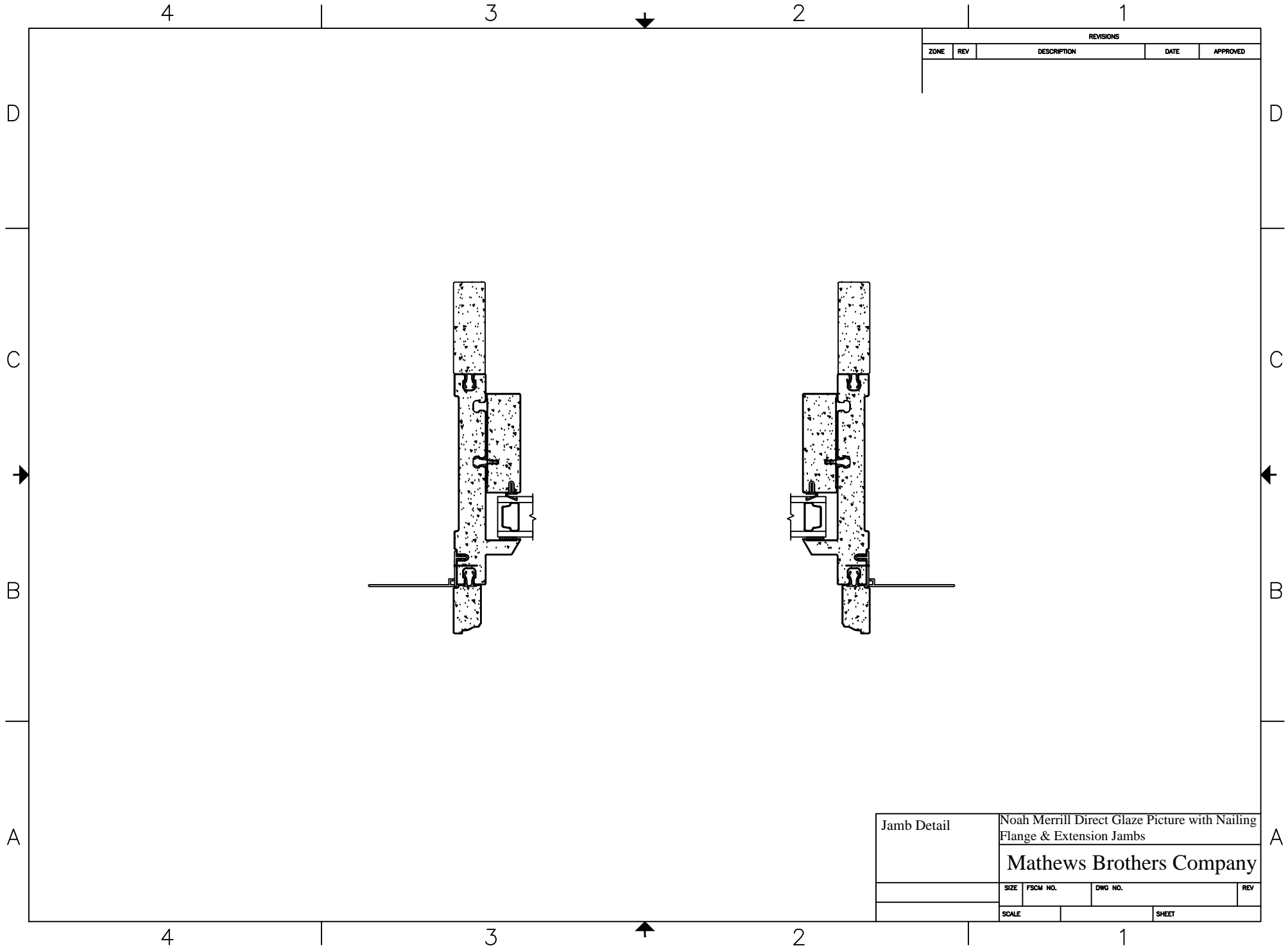

REVISIONS				
ZONE	REV	DESCRIPTION	DATE	APPROVED

Jamb Detail	Noah Merrill Direct Glaze Picture with Nailing Flange & Extension Jamb			
	Mathews Brothers Company			
	SIZE	FSCM NO.	DWG NO.	REV
	SCALE		SHEET	

5/25/10

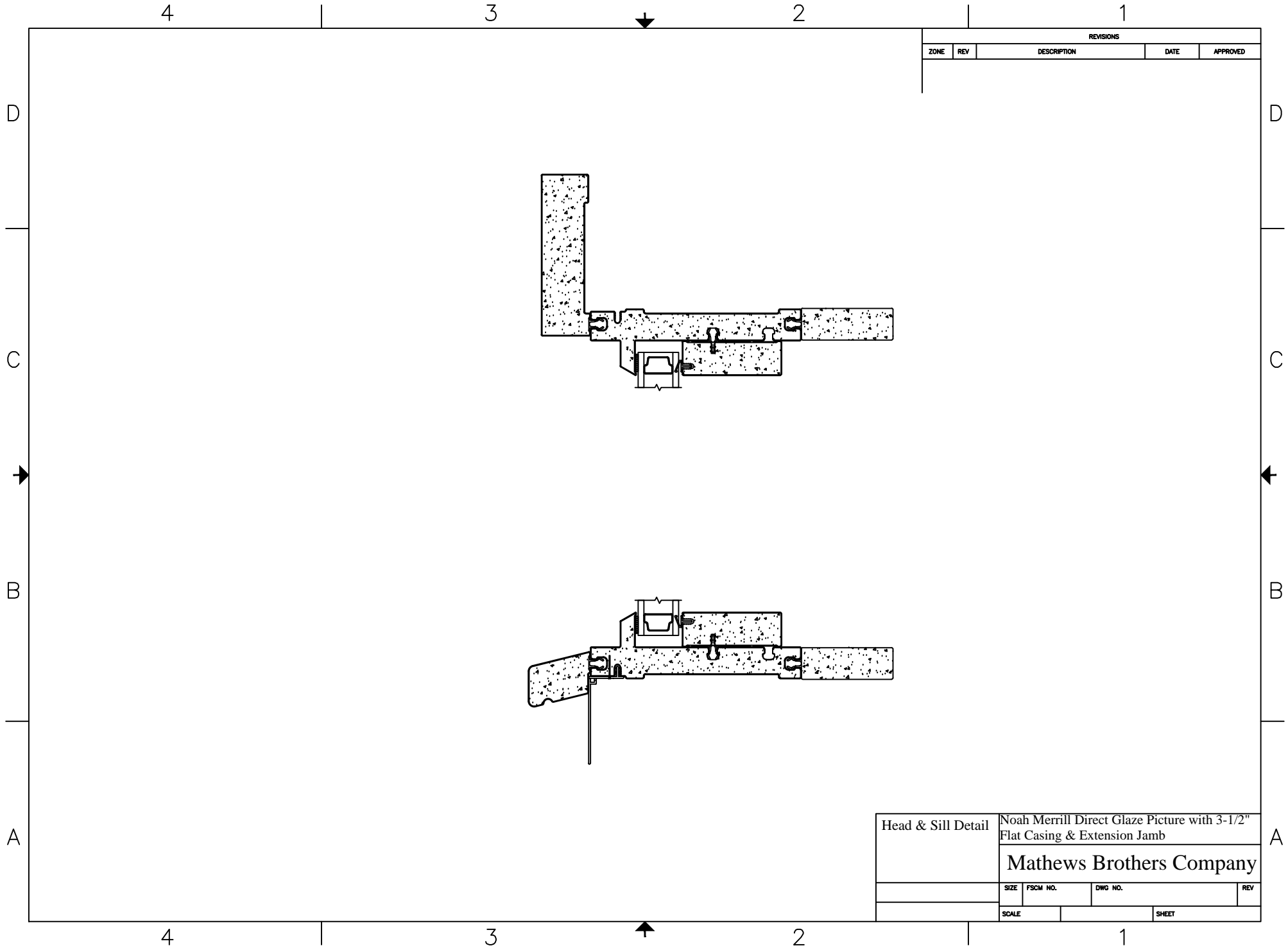

REVISIONS				
ZONE	REV	DESCRIPTION	DATE	APPROVED

Head & Sill Detail	Noah Merrill Direct Glaze Picture with 3-1/2" Flat Casing & Extension Jamb			
	Mathews Brothers Company			
	SIZE	FSCM NO.	DWG NO.	REV
	SCALE		SHEET	

5/25/10

D

C

B

A

4

3

2

1

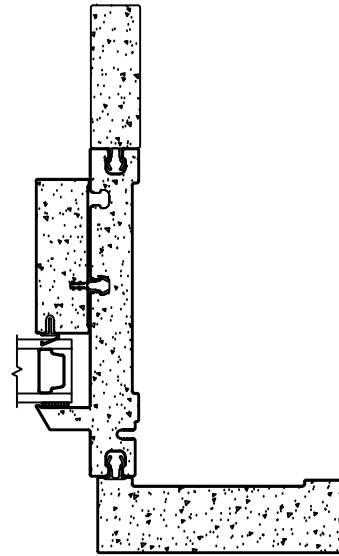
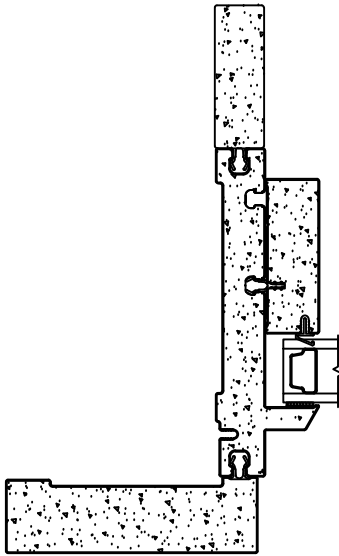

REVISIONS				
ZONE	REV	DESCRIPTION	DATE	APPROVED

Jamb Detail	Noah Merrill Direct Glaze Picture with 3-1/2" Flat Casing & Extension Jamb			
	Mathews Brothers Company			
	SIZE	FSCM NO.	DWG NO.	REV
	SCALE		SHEET	

4

3

2

1

D

C

B

A

5/25/10

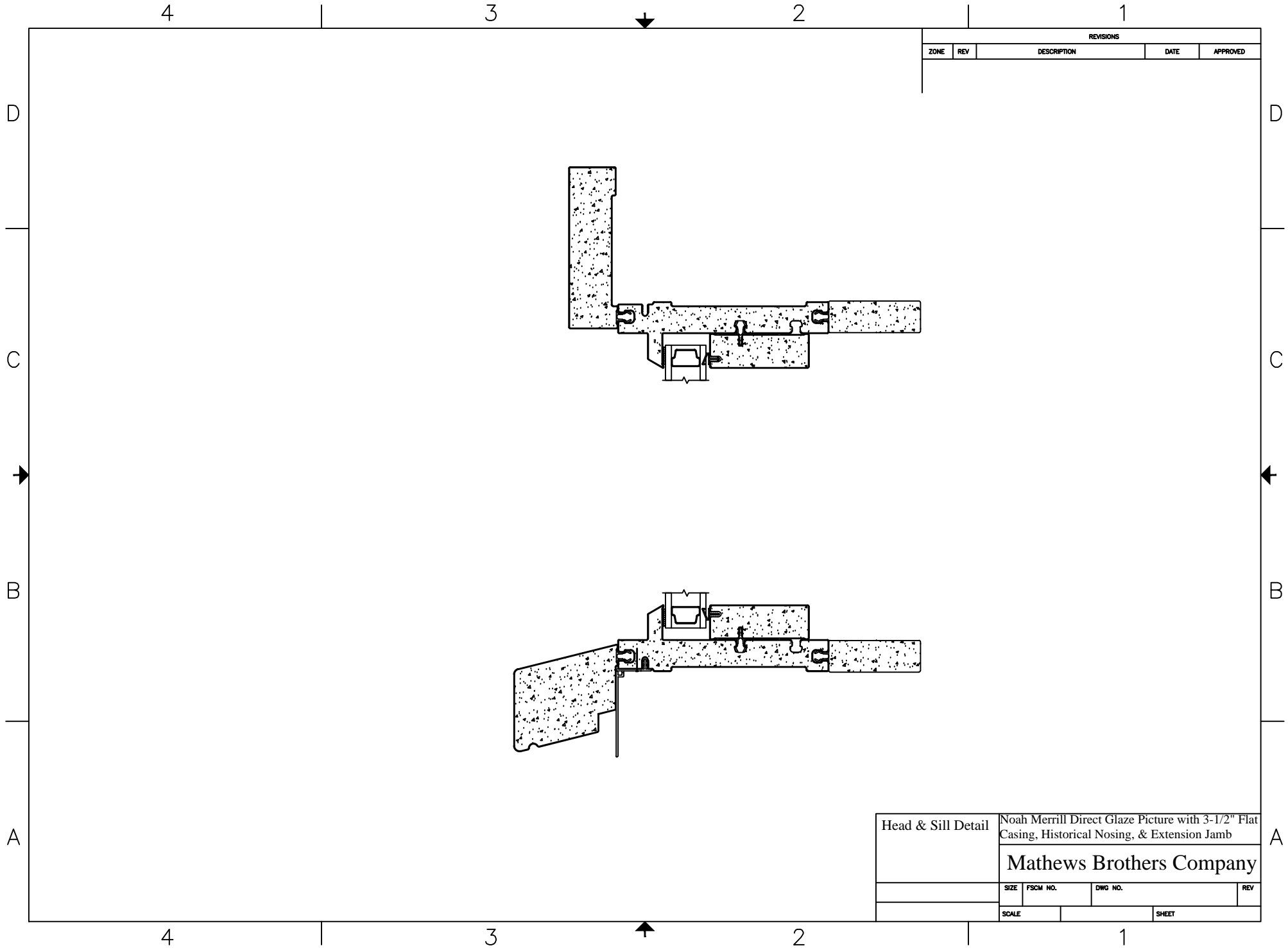

REVISIONS				
ZONE	REV	DESCRIPTION	DATE	APPROVED

Head & Sill Detail	Noah Merrill Direct Glaze Picture with 3-1/2" Flat Casing, Historical Nosing, & Extension Jamb			
	Mathews Brothers Company			
	SIZE	FSCM NO.	DWG NO.	REV
	SCALE			SHEET

5/25/10

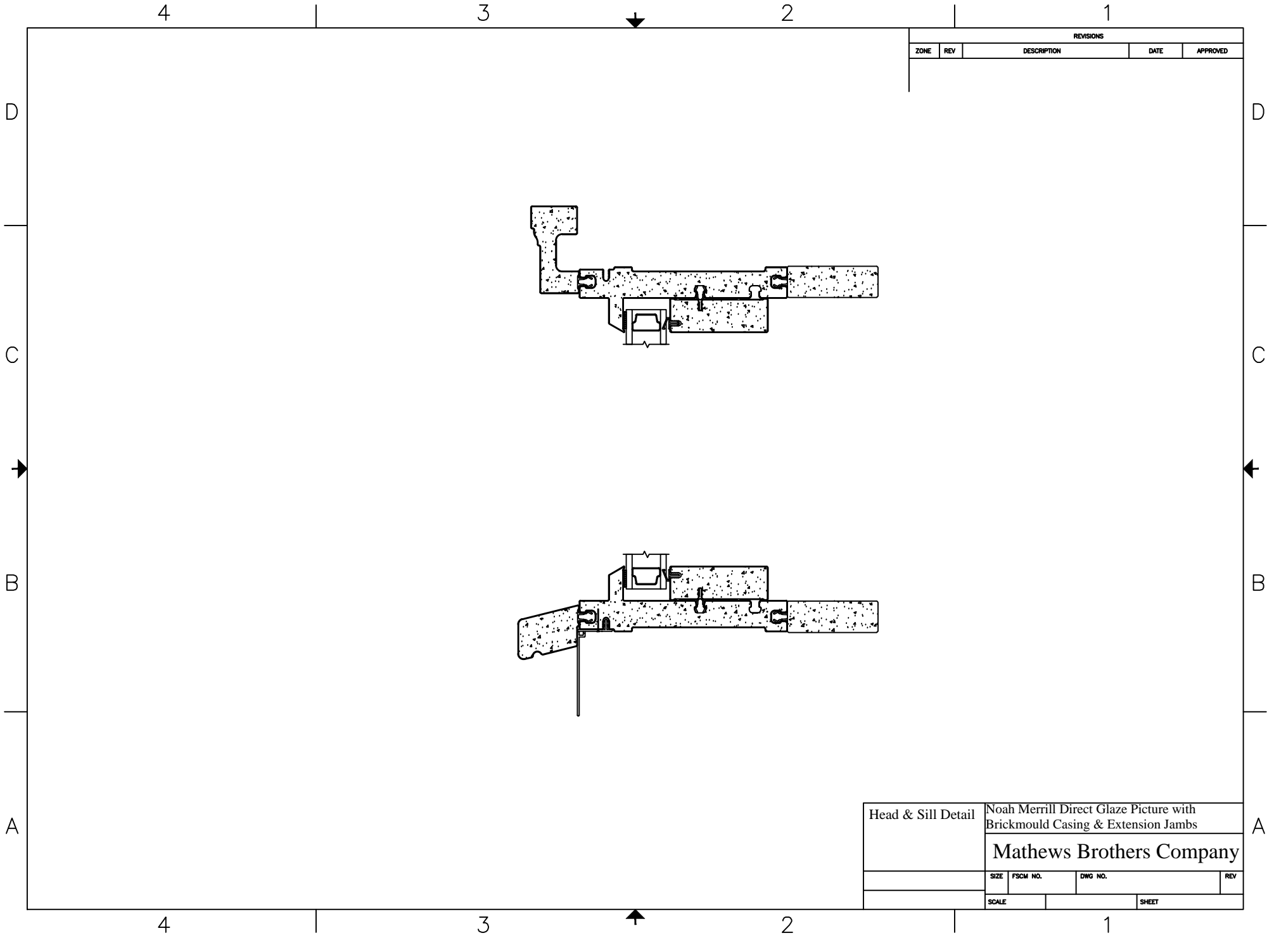

REVISIONS				
ZONE	REV	DESCRIPTION	DATE	APPROVED

Head & Sill Detail	Noah Merrill Direct Glaze Picture with Brickmould Casing & Extension Jambs			
	Mathews Brothers Company			
	SIZE	FSCM NO.	DWG NO.	REV
	SCALE		SHEET	

5/25/10

D

C

B

A

4

3

2

1

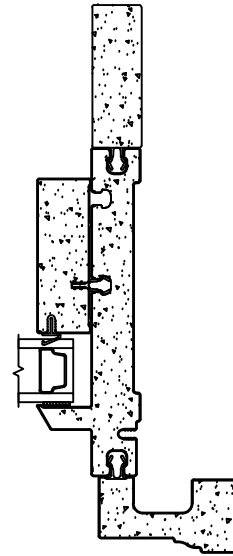
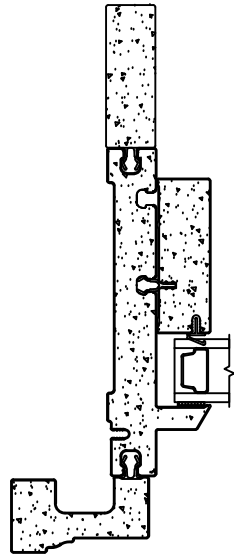

REVISIONS				
ZONE	REV	DESCRIPTION	DATE	APPROVED

Jamb Detail	Noah Merrill Direct Glaze Picture with Brickmould Casing & Extension Jamb			
	Mathews Brothers Company			
	SIZE	FSCM NO.	DWG NO.	REV
	SCALE		SHEET	

4

3

2

1



A

5/25/10

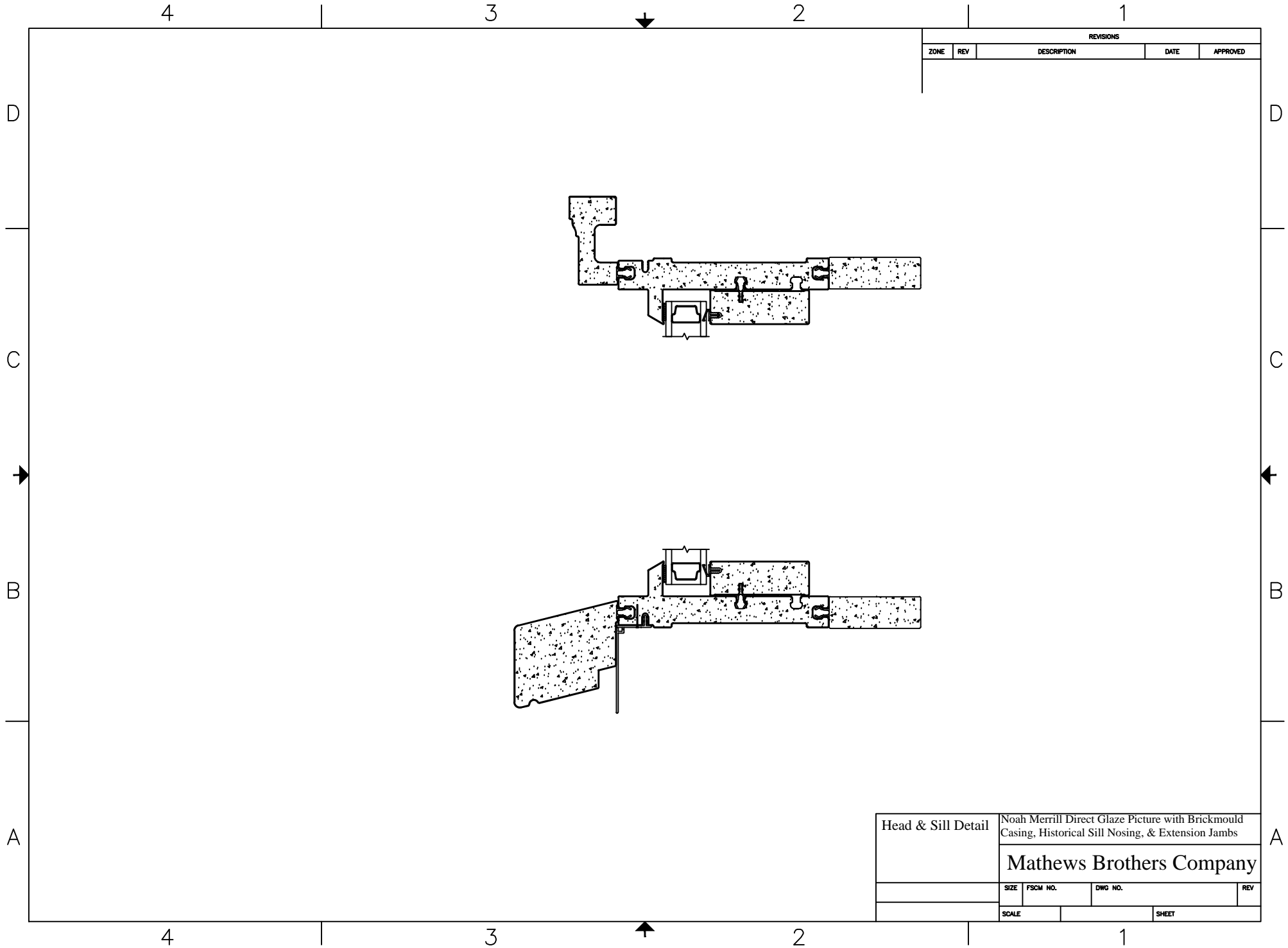

REVISIONS				
ZONE	REV	DESCRIPTION	DATE	APPROVED

Head & Sill Detail	Noah Merrill Direct Glaze Picture with Brickmould Casing, Historical Sill Nosing, & Extension Jambs			
	Mathews Brothers Company			
	SIZE	FSCM NO.	DWG NO.	REV
	SCALE		SHEET	