

Mathews Brothers  
Company

--	--	--	--	--

		DESCRIPTION: Sanford Hills New Construction Double Hung Direct Set Dual Pane		
"A"				DATE: September 17, 2018
SHEET:	DRAWN BY:	SCALE:		DWG NO.:

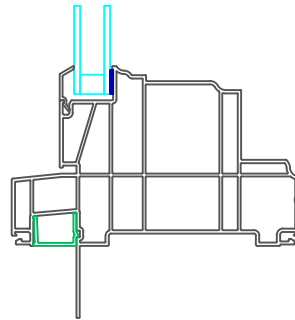
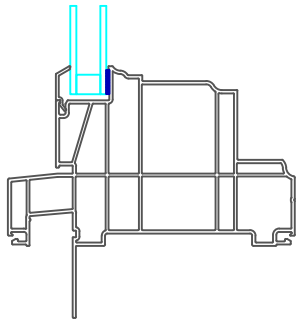
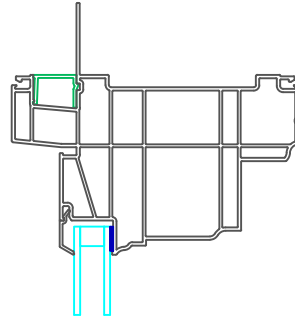
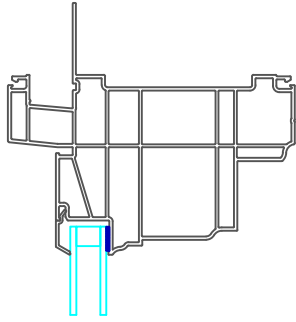

With J-Channel

With J-Channel Filler

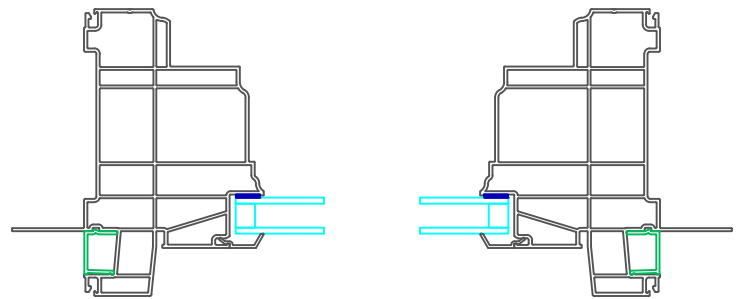
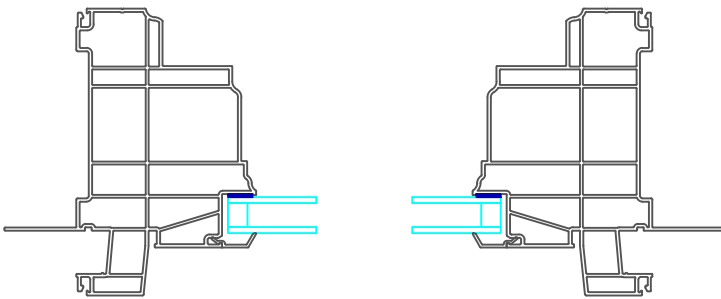

With J-Channel

With J-Channel Filler

Mathews Brothers  
Company

DESCRIPTION:

Sanford Hills New Construction Double Hung Direct Set  
Dual Pane

"A"

DATE:  
September 17, 2018

SHEET:  
SH\_CDPD-1

DRAWN BY:

SCALE:

DWG NO.:

1:4

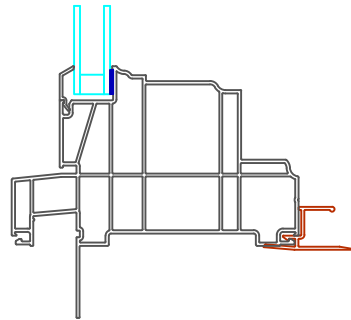
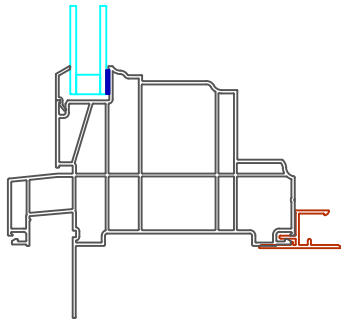
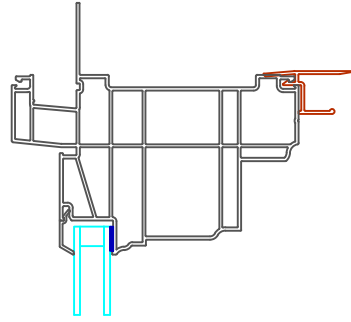
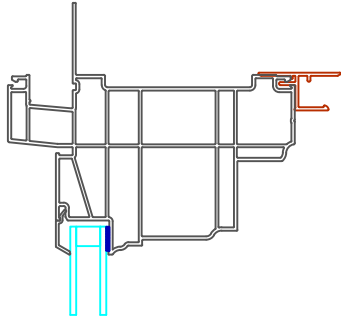

1/2" - 5/8" Drywall Return

3/4" Drywall Return

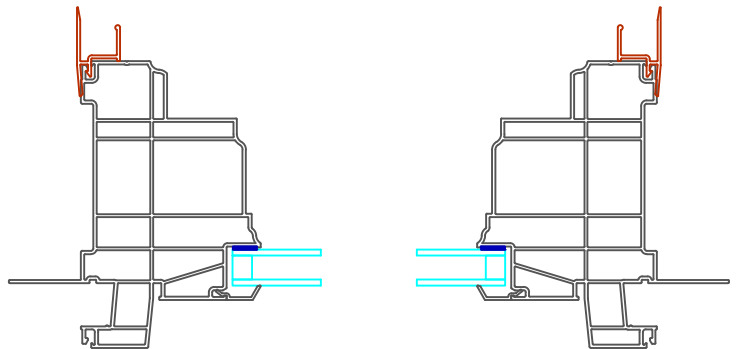
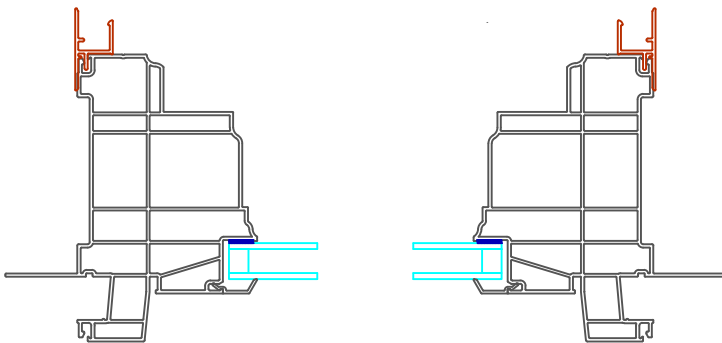

1/2" - 5/8" Drywall Return

3/4" Drywall Return

Mathews Brothers  
Company

		DESCRIPTION: Sanford Hills New Construction Double Hung Direct Set Dual Pane		
"A"				DATE: September 17, 2018
SHEET: SH_CDPD-2	DRAWN BY:	SCALE: 1:4		DWG NO.:

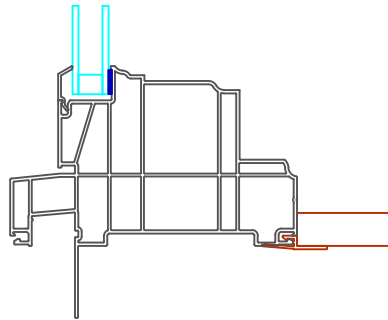
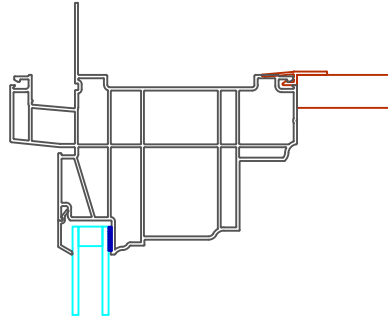

Extension Jamb

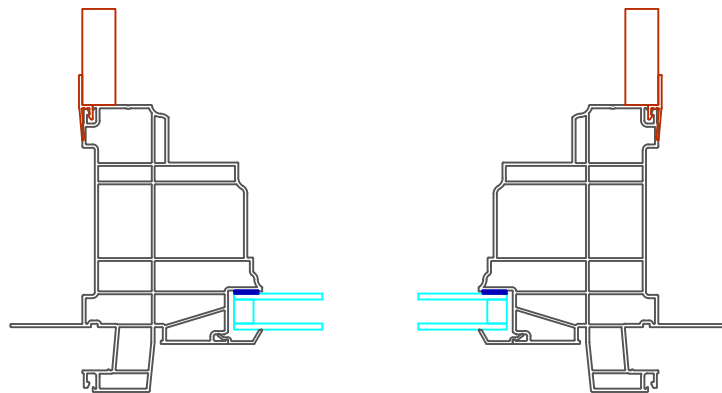

Extension Jamb

Mathews Brothers  
Company

DESCRIPTION:				
Sanford Hills New Construction Double Hung Direct Set Dual Pane				
"A"				DATE: September 17, 2018
SHEET: SH_CDPD-3	DRAWN BY:	SCALE: 1:4		DWG NO.:

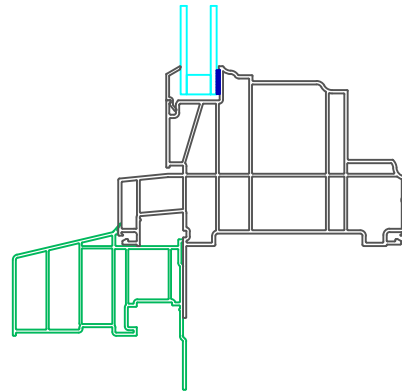
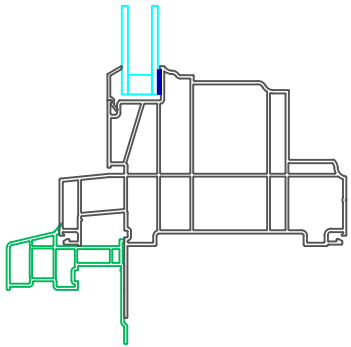
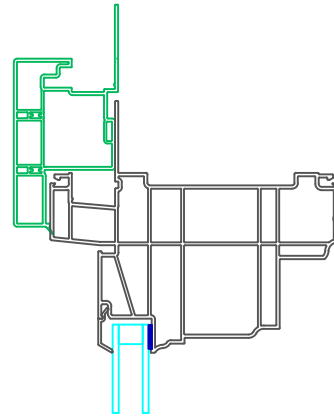
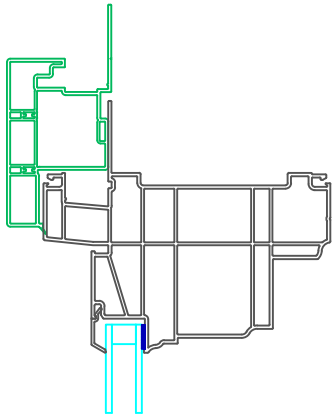

5/4 x 3-1/2 Flat Casing with J-Channel  
Standard Sill Nose

5/4 x 3-1/2 Flat Casing with J-Channel  
Historical Sill Nose

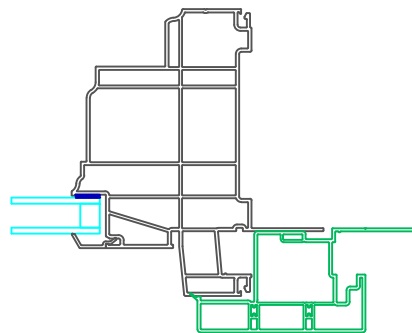
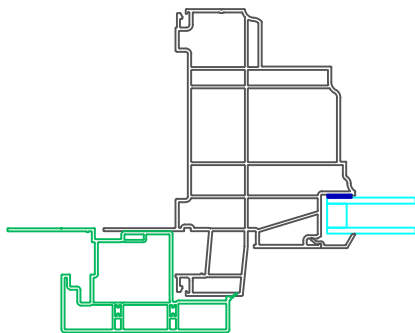

5/4 x 3-1/2 Flat Casing with J-Channel

Mathews Brothers  
Company

DESCRIPTION:		Sanford Hills New Construction Double Hung Direct Set Dual Pane		
"A"	DRAWN BY:	SCALE:	DATE:	September 17, 2018
SHEET: SH_CDPD-4		1:4	DWG NO.:	

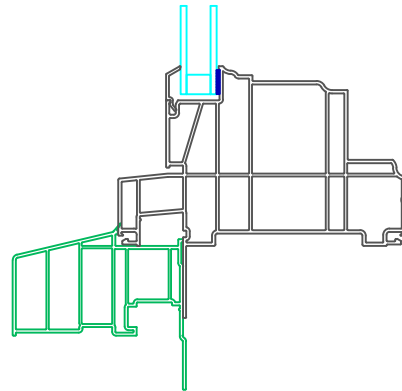
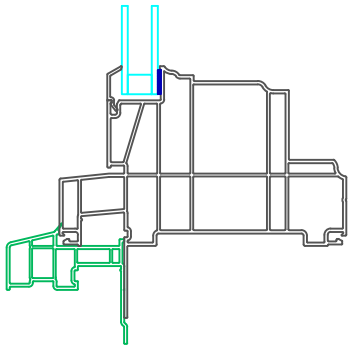
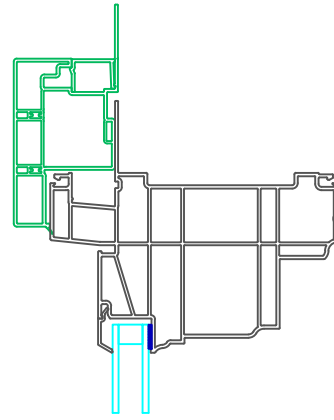
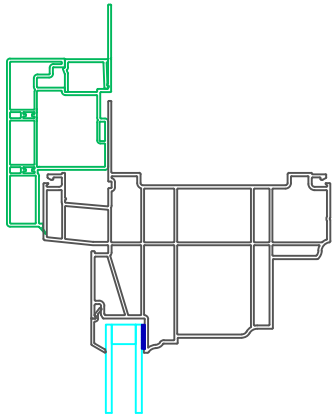

5/4 x 3-1/2 Flat Casing With J-Channel Filler  
Standard Sill Nose

5/4 x 3-1/2 Flat Casing With J-Channel Filler  
Historical Sill Nose

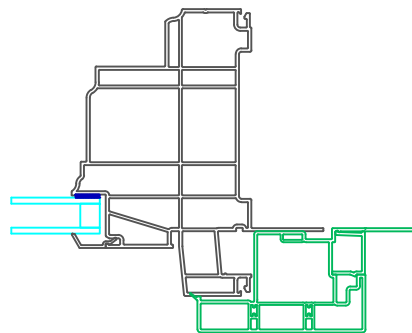
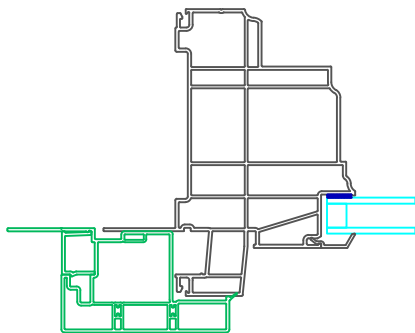

5/4 x 3-1/2 Flat Casing With J-Channel Filler

Mathews Brothers  
Company

		DESCRIPTION:	
		Sanford Hills New Construction Double Hung Direct Set Dual Pane	
"A"			DATE: September 17, 2018
SHEET: SH_CDPD-5	DRAWN BY:	SCALE: 1:4	DWG NO.:

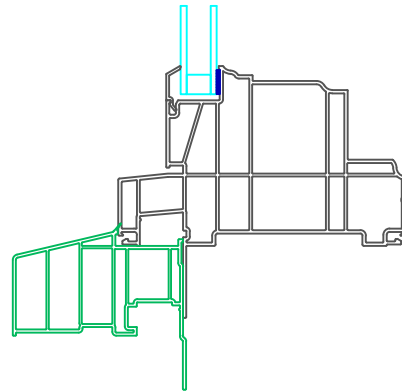
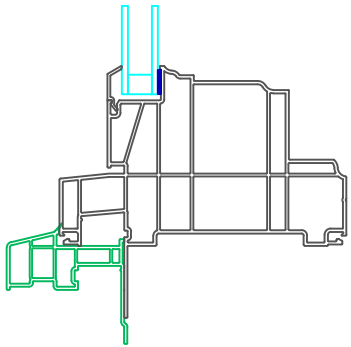
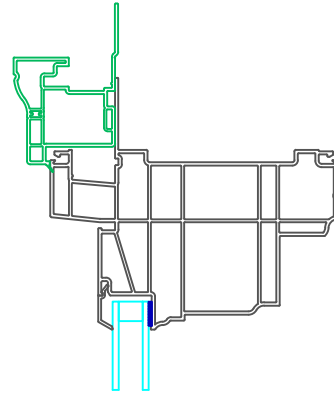
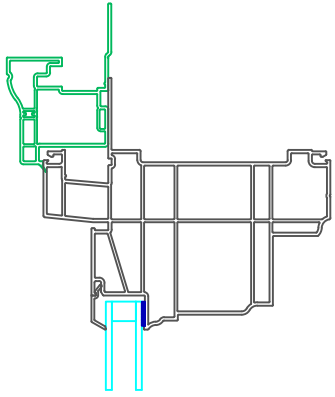

Brickmould Casing with J-Channel  
Standard Sill Nose

Brickmould Casing with J-Channel  
Historical Sill Nose

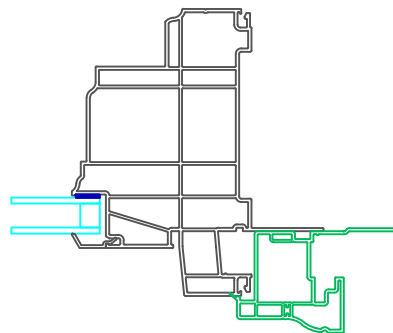
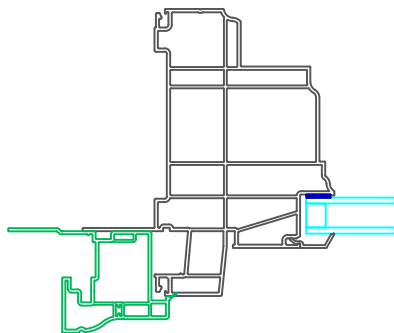

Brickmould Casing with J-Channel

Mathews Brothers  
Company

		DESCRIPTION: Sanford Hills New Construction Double Hung Direct Set Dual Pane		
"A"				DATE: September 17, 2018
SHEET: SH_CDPD-6	DRAWN BY:	SCALE: 1:4		DWG NO.:

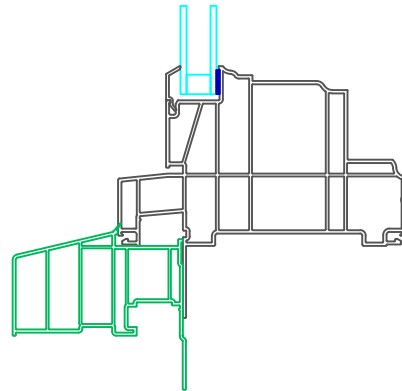
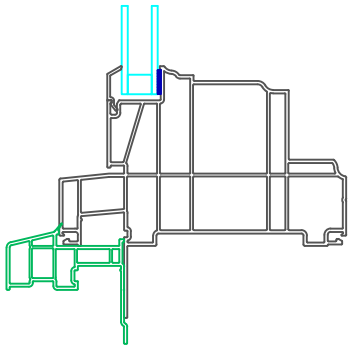
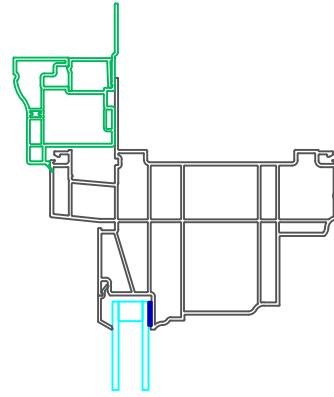
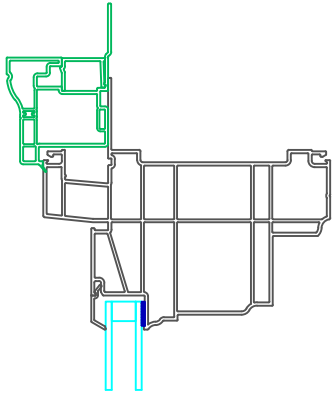

Brickmould Casing With J-Channel Filler  
Standard Sill Nose

Brickmould Casing With J-Channel Filler  
Historical Sill Nose

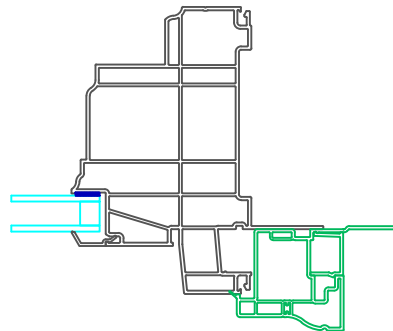
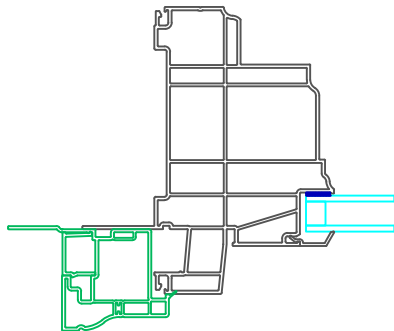

Brickmould Casing With J-Channel Filler

Mathews Brothers  
Company

		DESCRIPTION:	
		Sanford Hills New Construction Double Hung Direct Set Dual Pane	
"A"			DATE: September 17, 2018
SHEET: SH_CDPD-7	DRAWN BY:	SCALE: 1:4	DWG NO.:



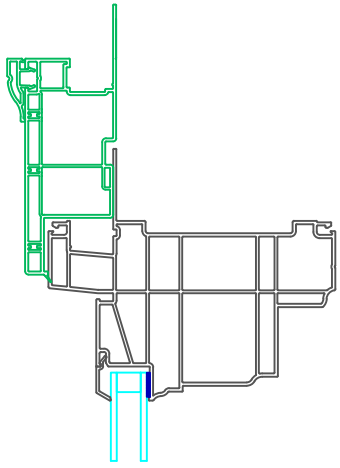

4-1/2 Banded Casing with J-Channel  
Standard Sill Nose

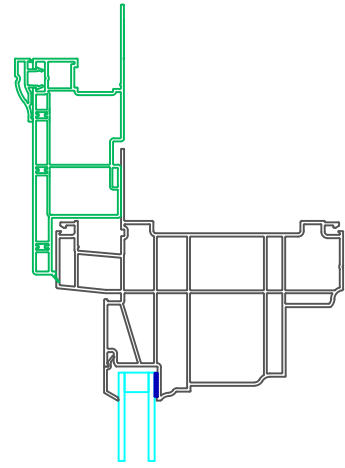

4-1/2 Banded Casing with J-Channel  
Historical Sill Nose

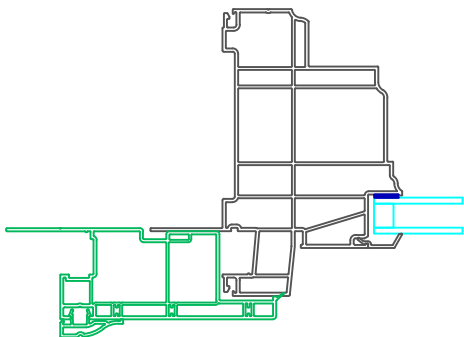
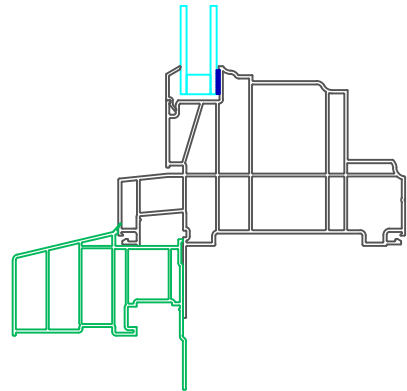
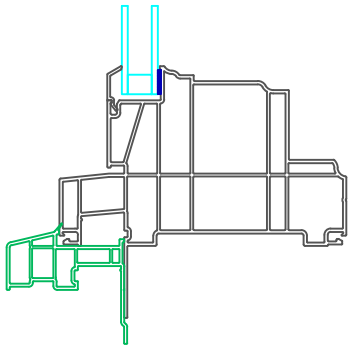

4-1/2 Banded Casing with J-Channel

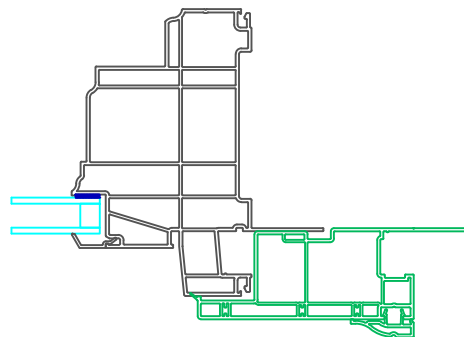

Mathews Brothers  
Company

		DESCRIPTION: Sanford Hills New Construction Double Hung Direct Set Dual Pane		
"A"				DATE: September 17, 2018
SHEET: SH_CDPD-8	DRAWN BY:	SCALE: 1:4		DWG NO.:

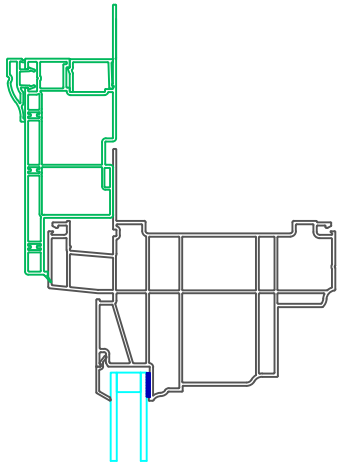

4-1/2 Banded Casing With J-Channel Filler  
Standard Sill Nose

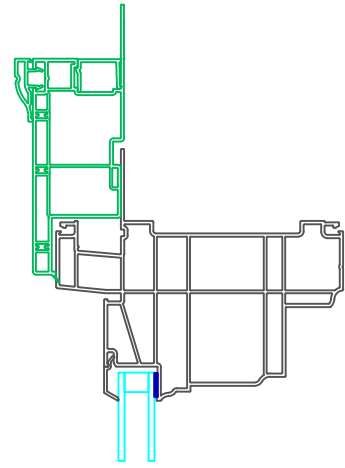

4-1/2 Banded Casing With J-Channel Filler  
Historical Sill Nose

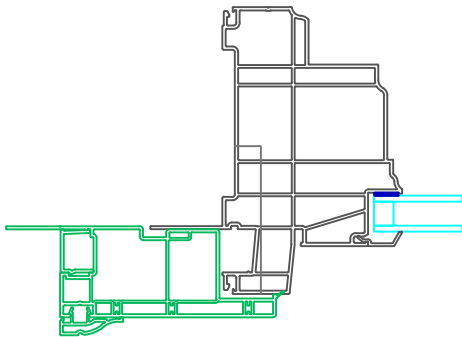
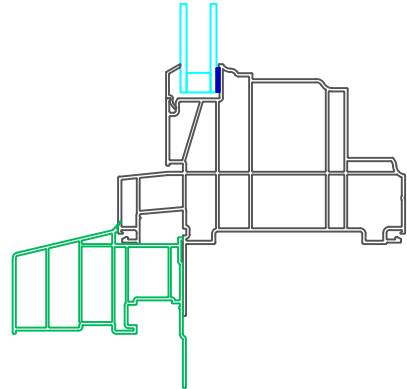
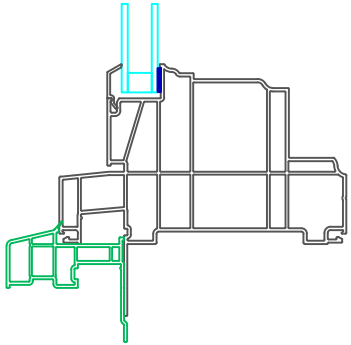

4-1/2 Banded Casing With J-Channel Filler

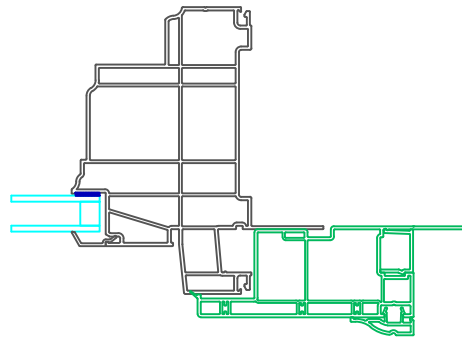

Mathews Brothers  
Company

		DESCRIPTION:	
		Sanford Hills New Construction Double Hung Direct Set Dual Pane	
"A"			DATE: September 17, 2018
SHEET: SH_CDPD-9	DRAWN BY:	SCALE: 1:4	DWG NO.:

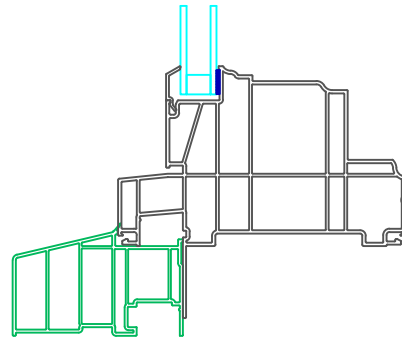
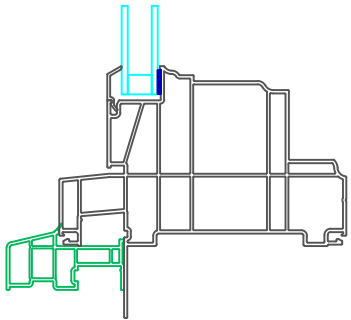
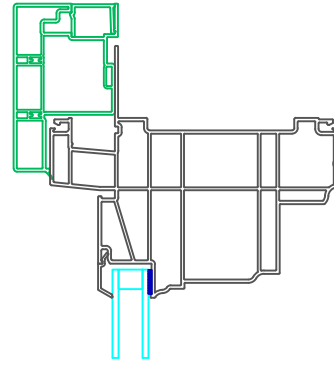
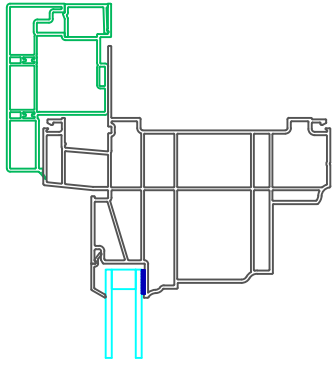

5/4 x 3-1/2 Flat Casing with Nailing Fin Removed  
Standard Sill Nose

5/4 x 3-1/2 Flat Casing with Nailing Fin Removed  
Historical Sill Nose

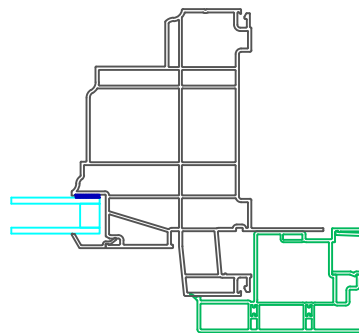
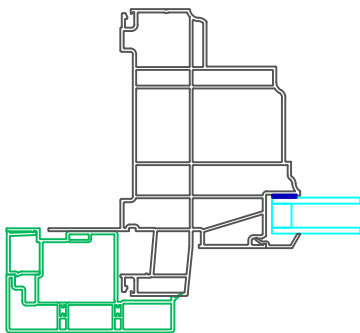

5/4 x 3-1/2 Flat Casing with Nailing Fin Removed

Mathews Brothers  
Company

DESCRIPTION:		Sanford Hills New Construction Double Hung Direct Set Dual Pane		
"A"	DRAWN BY:	SCALE:	DATE:	September 17, 2018
SHEET: SH_CDPD-10		1:4	DWG NO.:	

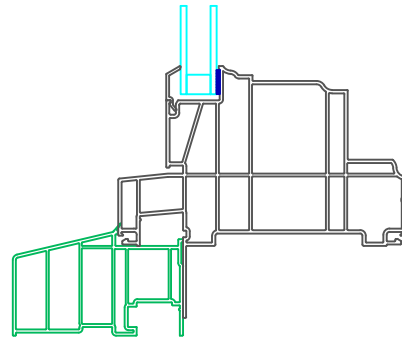
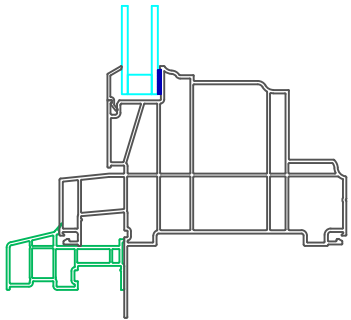
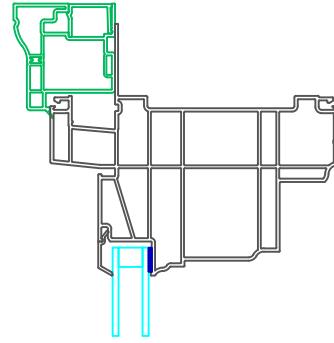
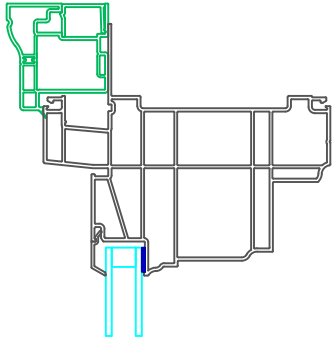

Brickmould Casing With Nailing Fin Removed  
Standard Sill Nose

Brickmould Casing With Nailing Fin Removed  
Historical Sill Nose

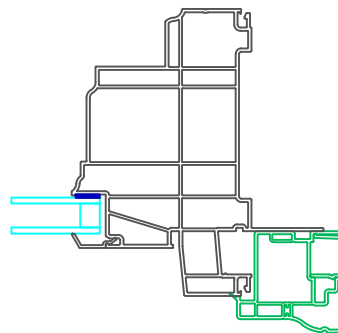
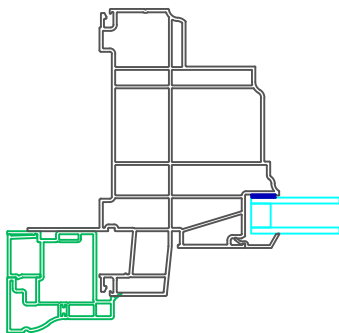

Brickmould Casing With Nailing Fin Removed

Mathews Brothers  
Company

		DESCRIPTION:	
		Sanford Hills New Construction Double Hung Direct Set Dual Pane	
"A"			DATE: September 17, 2018
SHEET: SH_CPD-11	DRAWN BY:	SCALE: 1:4	DWG NO.:

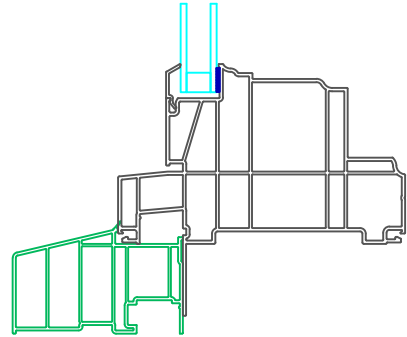
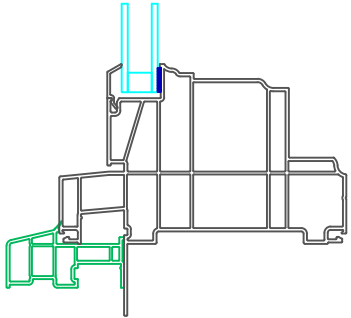
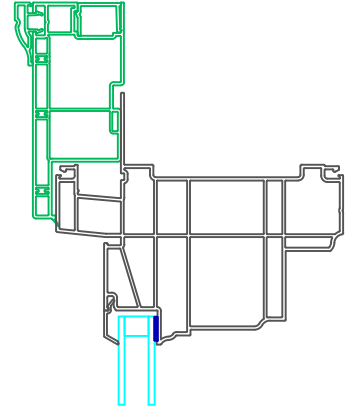
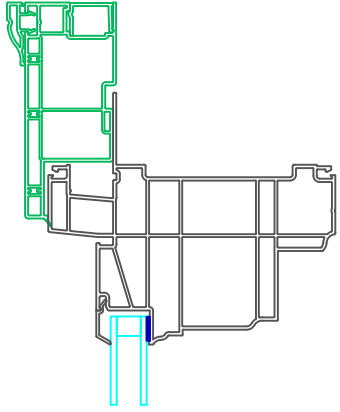

4-1/2 Banded Casing With Nailing Fin Removed  
Standard Sill Nose

4-1/2 Banded Casing With Nailing Fin Removed  
Historical Sill Nose

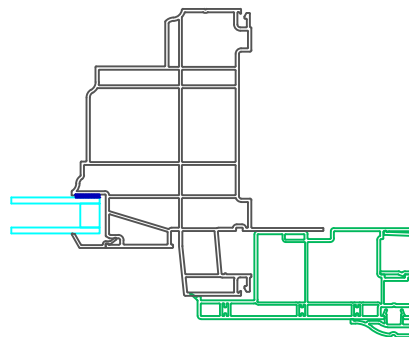
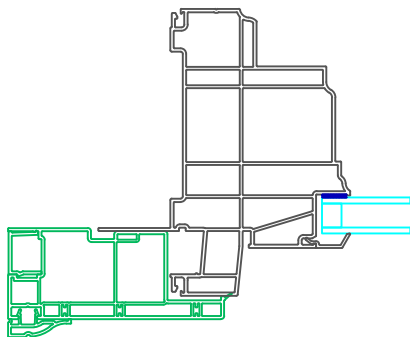

4-1/2 Banded Casing With Nailing Fin Removed

Mathews Brothers  
Company

DESCRIPTION:		Sanford Hills New Construction Double Hung Direct Set Dual Pane		
"A"	DRAWN BY:	SCALE:	DATE:	September 17, 2018
SHEET: SH_CPD-12		1:4	DWG NO.:	

Shown with Optional Installation Straps

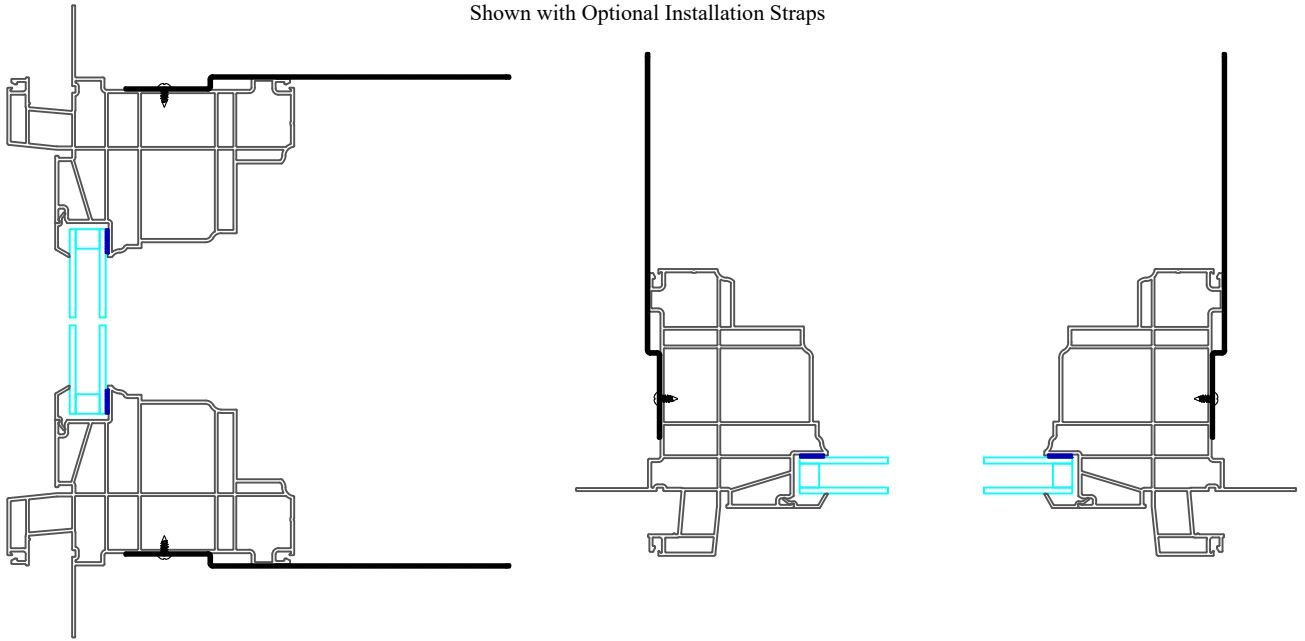

Grille in Airspace and Simulated Divided Lite Options

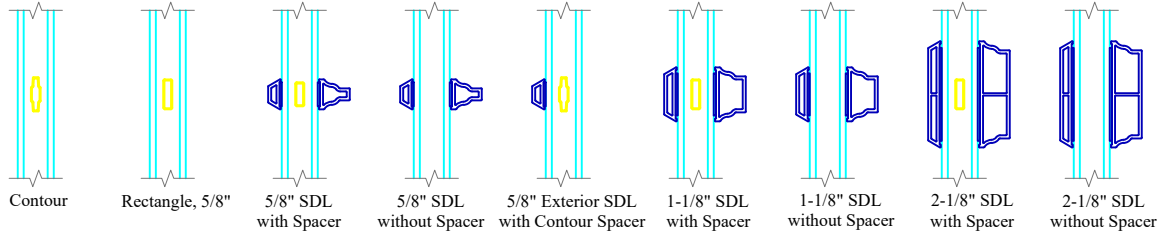

Nailing Flange Removed Option

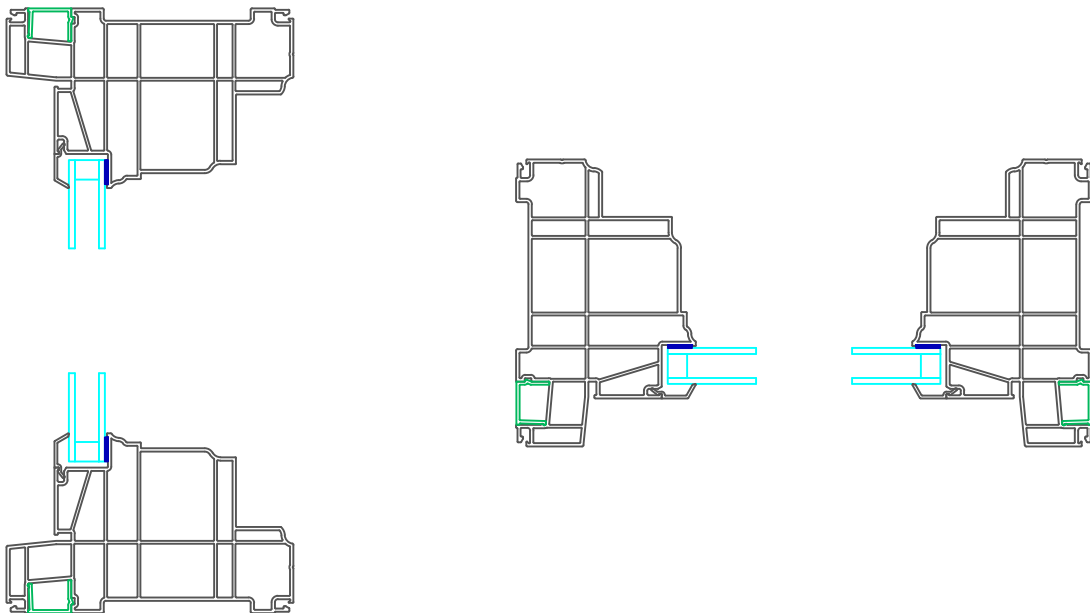

Mathews Brothers  
Company

DESCRIPTION:		Sanford Hills New Construction Double Hung Direct Set Dual Pane		
"A"				DATE: September 17, 2018
SHEET: SH_CPDP-13	DRAWN BY:	SCALE: 1:4		DWG NO.:

Narrow Mull Detail

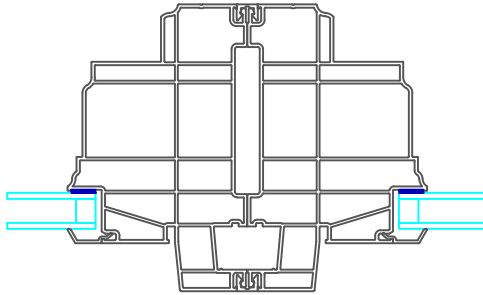

Narrow Mull Detail - Veneer Interior

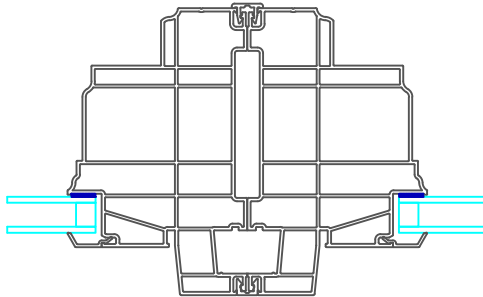

Mathews Brothers  
Company

		DESCRIPTION: Sanford Hills New Construction Double Hung Direct Set Dual Pane		
"A"				DATE: September 17, 2018
SHEET: SH_CDPD-14	DRAWN BY:	SCALE: 1:4		DWG NO.: